

# STAP 1

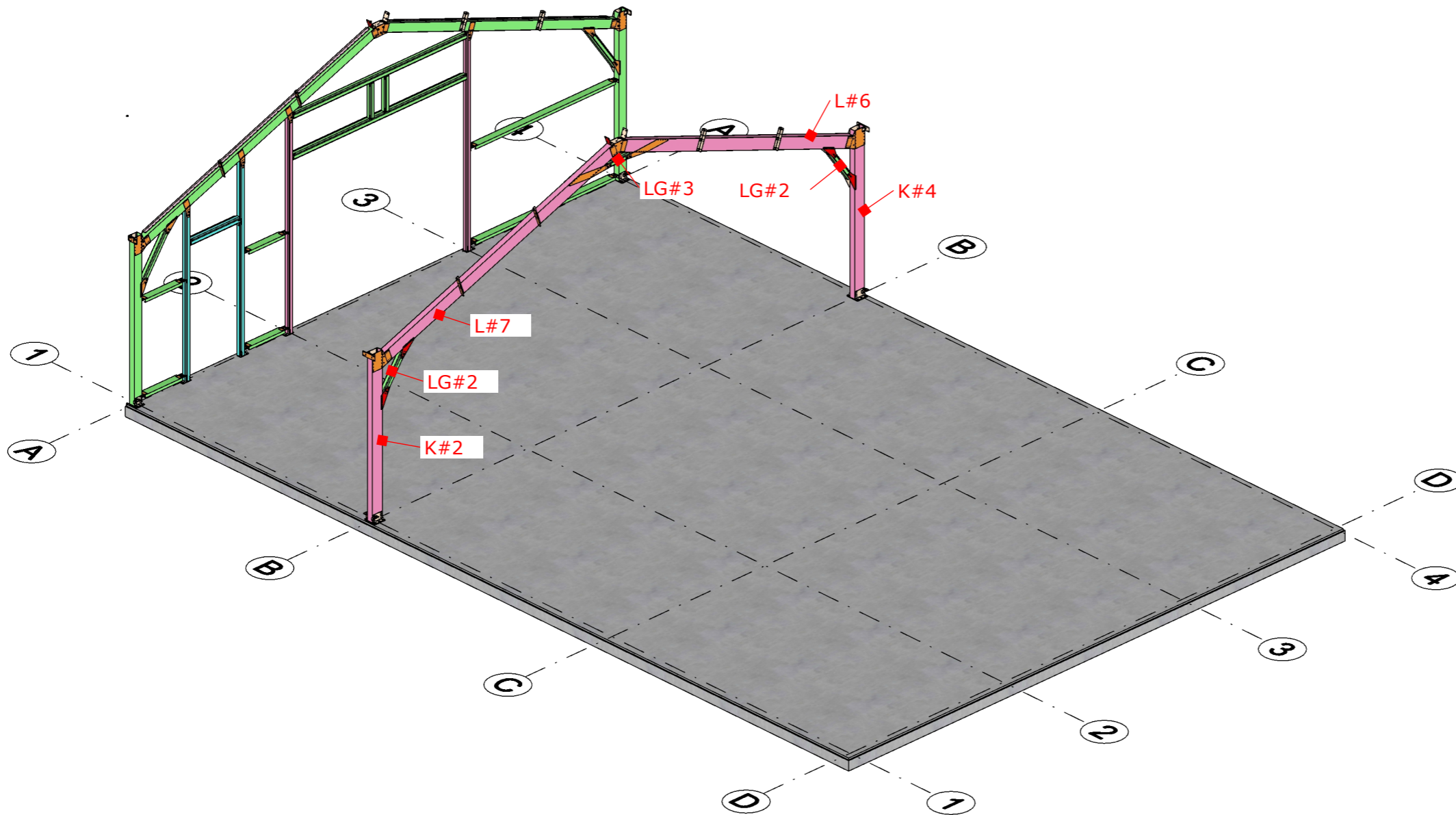

Reijrink Skellet B.V.  
 Kalundborg 10  
 5026 SE Tilburg  
 Nederland  
 t: +31 (0)13 504 1585  
 e: info@reijrink-skellet.com  
 w: http://www.reijrink-skellet.com

OPDRACHT:	Loods 15 x 10 x 2.8m																		
FASE:	D.O.																		
BOUWPLAATS:																			
OPMERKINGEN:	- Incl. pv-cellen																		
OPDRACHTGEVER:	Huisman Gemert Oost-Om 29 5422 VX Gemert Nederland																		
WIJZIGINGEN:	<table border="1"> <thead> <tr> <th>versie</th> <th>datum</th> <th>wijziging</th> </tr> </thead> <tbody> <tr><td> </td><td> </td><td> </td></tr> <tr><td> </td><td> </td><td> </td></tr> <tr><td> </td><td> </td><td> </td></tr> <tr><td> </td><td> </td><td> </td></tr> <tr><td> </td><td> </td><td> </td></tr> </tbody> </table>	versie	datum	wijziging															
versie	datum	wijziging																	
INHOUD:	STAP 1																		



## STAP 2



Reijrink Skellet B.V.  
 Kalundborg 10  
 5026 SE Tilburg  
 Nederland  
 t: +31 (0)13 504 1585  
 e: info@reijrink-skellet.com  
 w: http://www.reijrink-skellet.com

OPDRACHT: Loods 15 x 10 x 2.8m

FASE: D.O.

BOUWPLAATS:

OPMERKINGEN: - Incl. pv-cellen

OPDRACHTGEVER: Huisman Gemert  
 Oost-Om 29  
 5422 VX Gemert  
 Nederland

WIJZIGINGEN:	versie	datum	wijziging

INHOUD: STAP 2



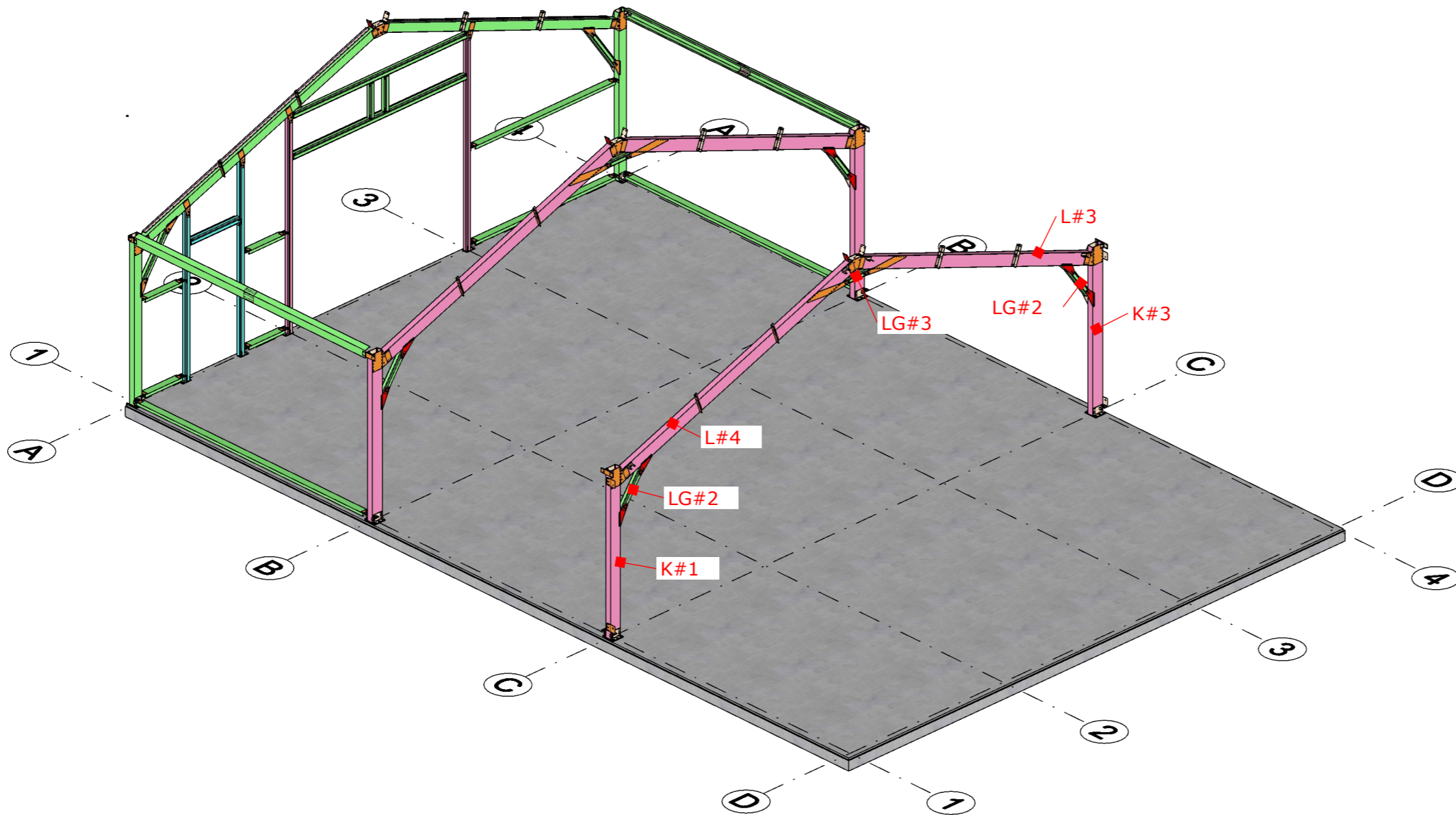

## STAP 4



Reijrink Skellet B.V.  
 Kalundborg 10  
 5026 SE Tilburg  
 Nederland  
 t: +31 (0)13 504 1585  
 e: info@reijrink-skellet.com  
 w: http://www.reijrink-skellet.com

OPDRACHT: Loods 15 x 10 x 2.8m

FASE: D.O.

BOUWPLAATS:

OPMERKINGEN: - Incl. pv-cellen

OPDRACHTGEVER: Huisman Gemert  
 Oost-Om 29  
 5422 VX Gemert  
 Nederland

WIJZIGINGEN:	versie	datum	wijziging

INHOUD: STAP 4







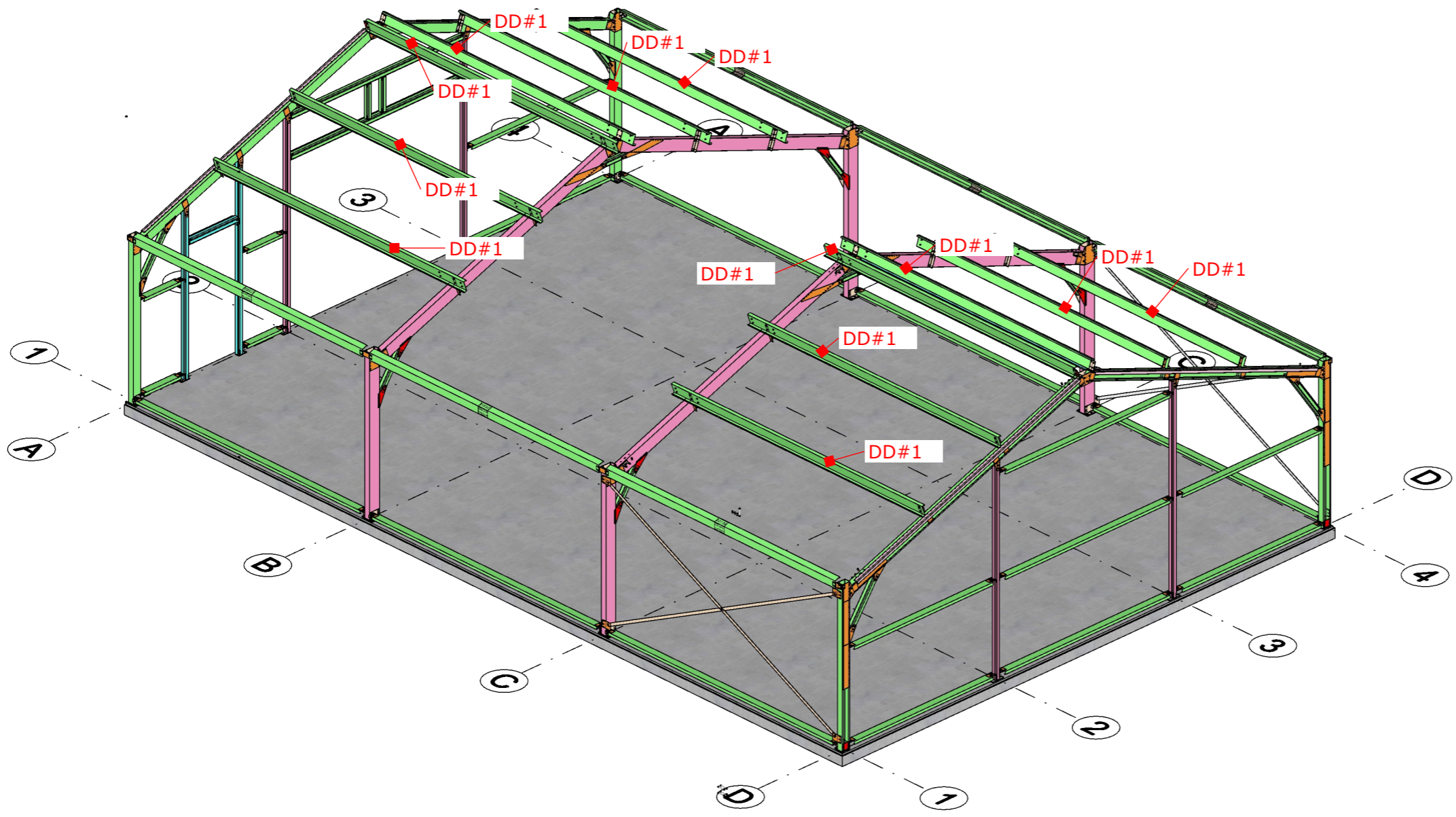

# STAP 8



Reijrink Skellet B.V.  
 Kalundborg 10  
 5026 SE Tilburg  
 Nederland  
 t: +31(0)13 504 1585  
 e: info@reijrink-skellet.com  
 w: http://www.reijrink-skellet.com

OPDRACHT:	Loods 15 x 10 x 2.8m																		
FASE:	D.O.																		
BOUWPLAATS:																			
OPMERKINGEN:	- Incl. pv-cellen																		
OPDRACHTGEVER:	Huisman Gemert Oost-Om 29 5422 VX Gemert Nederland																		
WIJZIGINGEN:	<table border="1"> <thead> <tr> <th>versie</th> <th>datum</th> <th>wijziging</th> </tr> </thead> <tbody> <tr><td> </td><td> </td><td> </td></tr> <tr><td> </td><td> </td><td> </td></tr> <tr><td> </td><td> </td><td> </td></tr> <tr><td> </td><td> </td><td> </td></tr> <tr><td> </td><td> </td><td> </td></tr> </tbody> </table>	versie	datum	wijziging															
versie	datum	wijziging																	
INHOUD:	STAP 8																		



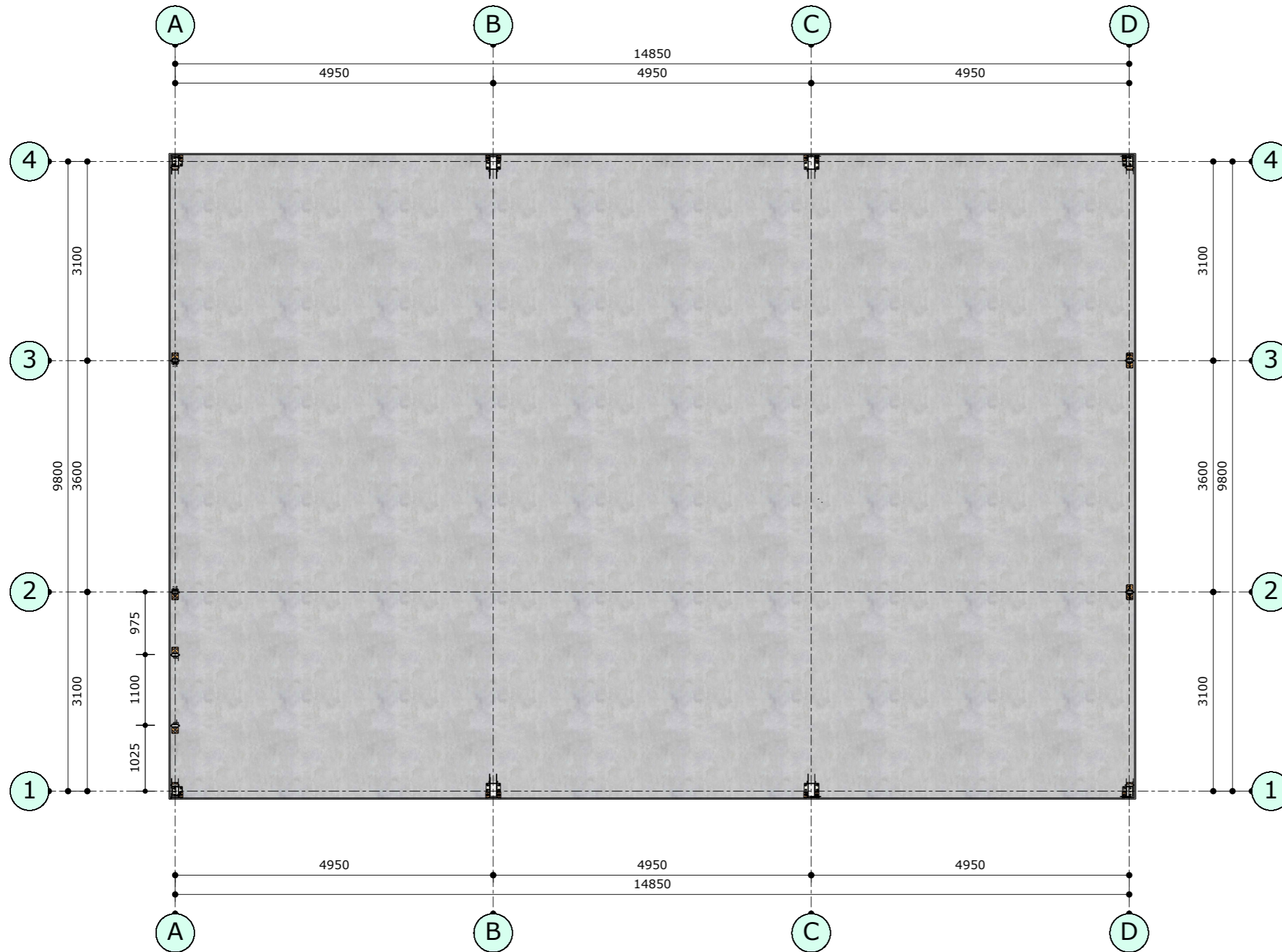

# ANKERPLAN



Reijrink Skellet B.V.  
 Kalundborg 10  
 5026 SE Tilburg  
 Nederland  
 t: +31(0)13 504 1585  
 e: info@reijrink-skellet.com  
 w: http://www.reijrink-skellet.com

OPDRACHT:	Loods 15 x 10 x 2.8m																		
FASE:	D.O.																		
BOUWPLAATS:																			
OPMERKINGEN:	- Incl. pv-cellen																		
OPDRACHTGEVER:	Huisman Gemert Oost-Om 29 5422 VX Gemert Nederland																		
WIJZIGINGEN:	<table border="1"> <thead> <tr> <th>versie</th> <th>datum</th> <th>wijziging</th> </tr> </thead> <tbody> <tr><td> </td><td> </td><td> </td></tr> <tr><td> </td><td> </td><td> </td></tr> <tr><td> </td><td> </td><td> </td></tr> <tr><td> </td><td> </td><td> </td></tr> <tr><td> </td><td> </td><td> </td></tr> </tbody> </table>	versie	datum	wijziging															
versie	datum	wijziging																	
INHOUD:	ANKERPLAN																		

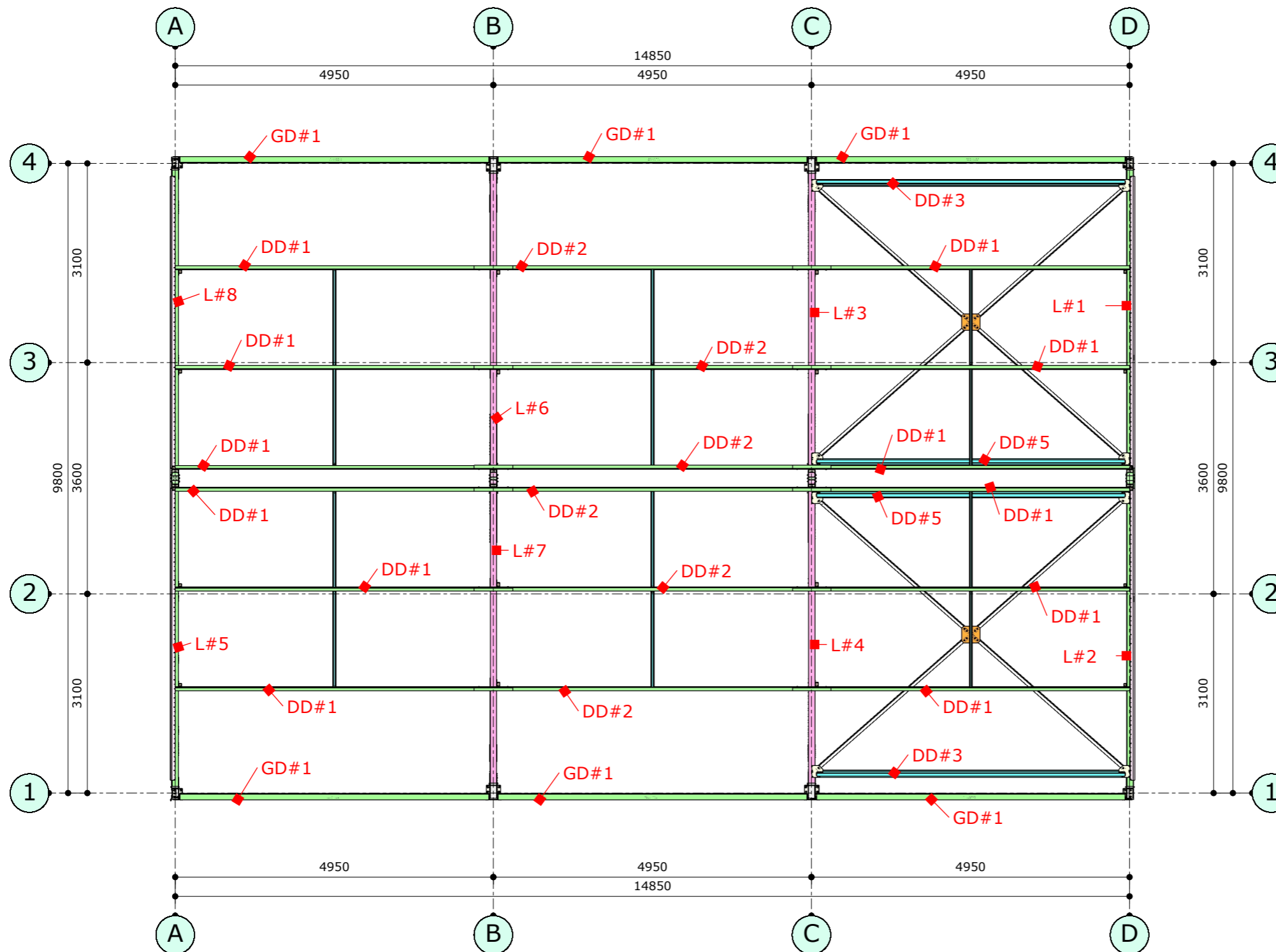

# DAK



Reijrink Skellet B.V.  
 Kalundborg 10  
 5026 SE Tilburg  
 Nederland  
 t: +31(0)13 504 1585  
 e: info@reijrink-skellet.com  
 w: http://www.reijrink-skellet.com

OPDRACHT:	Loods 15 x 10 x 2.8m																		
FASE:	D.O.																		
BOUWPLAATS:																			
OPMERKINGEN:	- Incl. pv-cellen																		
OPDRACHTGEVER:	Huisman Gemert Oost-Om 29 5422 VX Gemert Nederland																		
WIJZIGINGEN:	<table border="1"> <thead> <tr> <th>versie</th> <th>datum</th> <th>wijziging</th> </tr> </thead> <tbody> <tr><td> </td><td> </td><td> </td></tr> <tr><td> </td><td> </td><td> </td></tr> <tr><td> </td><td> </td><td> </td></tr> <tr><td> </td><td> </td><td> </td></tr> <tr><td> </td><td> </td><td> </td></tr> </tbody> </table>	versie	datum	wijziging															
versie	datum	wijziging																	

INHOUD:	DAK
---------	-----

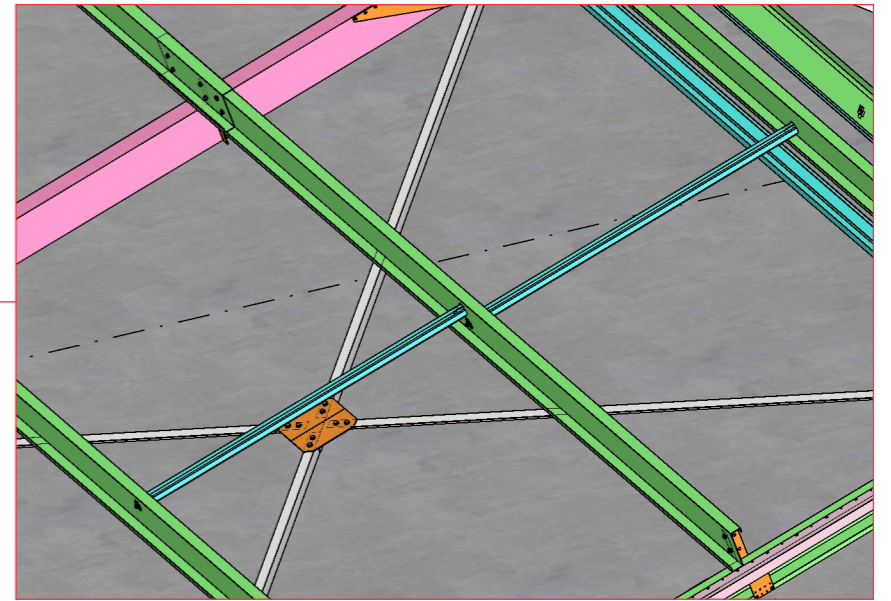
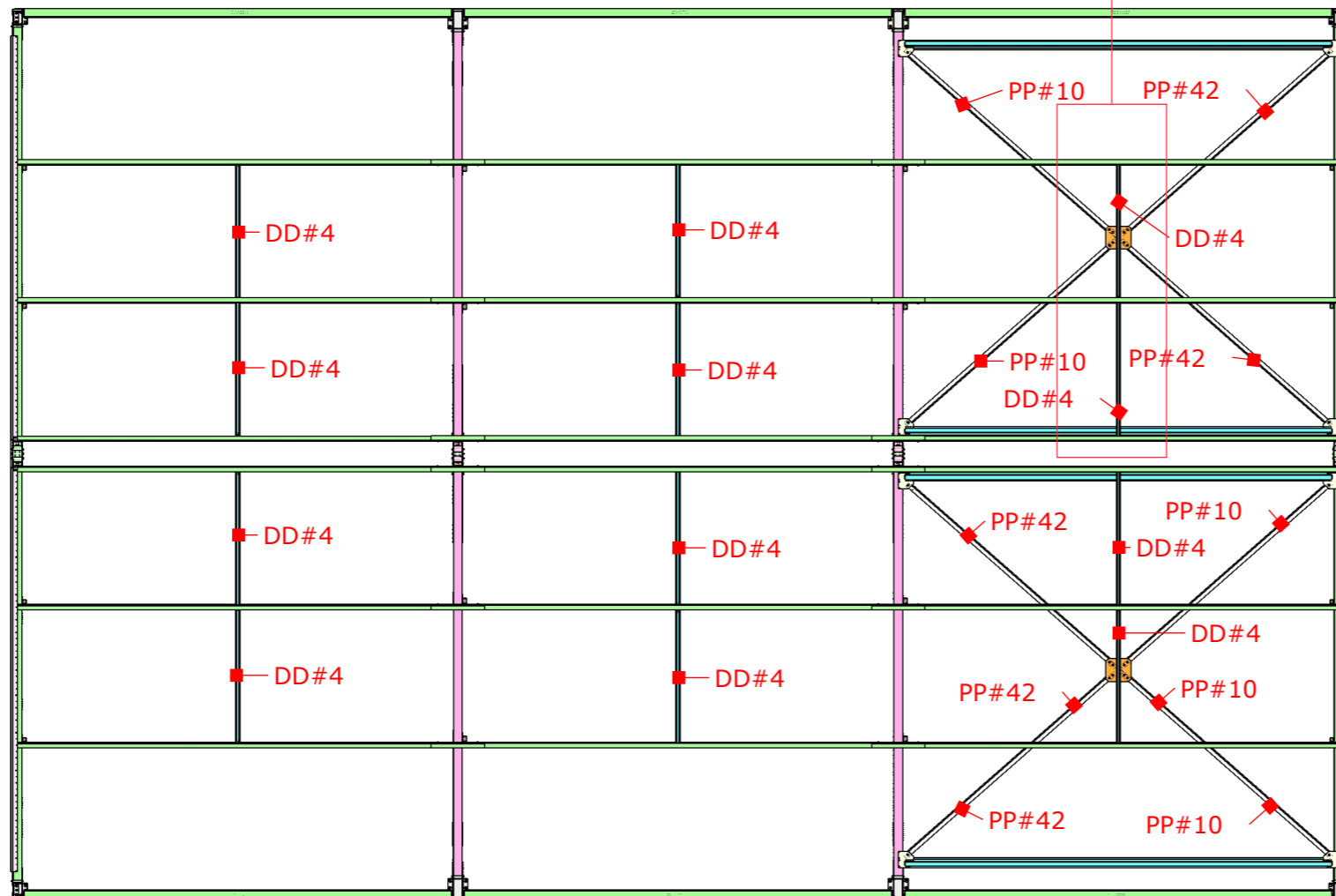

## DAK 2



Reijrink Skellet B.V.  
 Kalundborg 10  
 5026 SE Tilburg  
 Nederland  
 t: +31(0)13 504 1585  
 e: info@reijrink-skellet.com  
 w: http://www.reijrink-skellet.com

OPDRACHT: Loods 15 x 10 x 2.8m

FASE: D.O.

BOUWPLAATS:

OPMERKINGEN: - Incl. pv-cellen

OPDRACHTGEVER: Huisman Gemert  
 Oost-Om 29  
 5422 VX Gemert  
 Nederland

WIJZIGINGEN:	versie	datum	wijziging

INHOUD: DAK 2



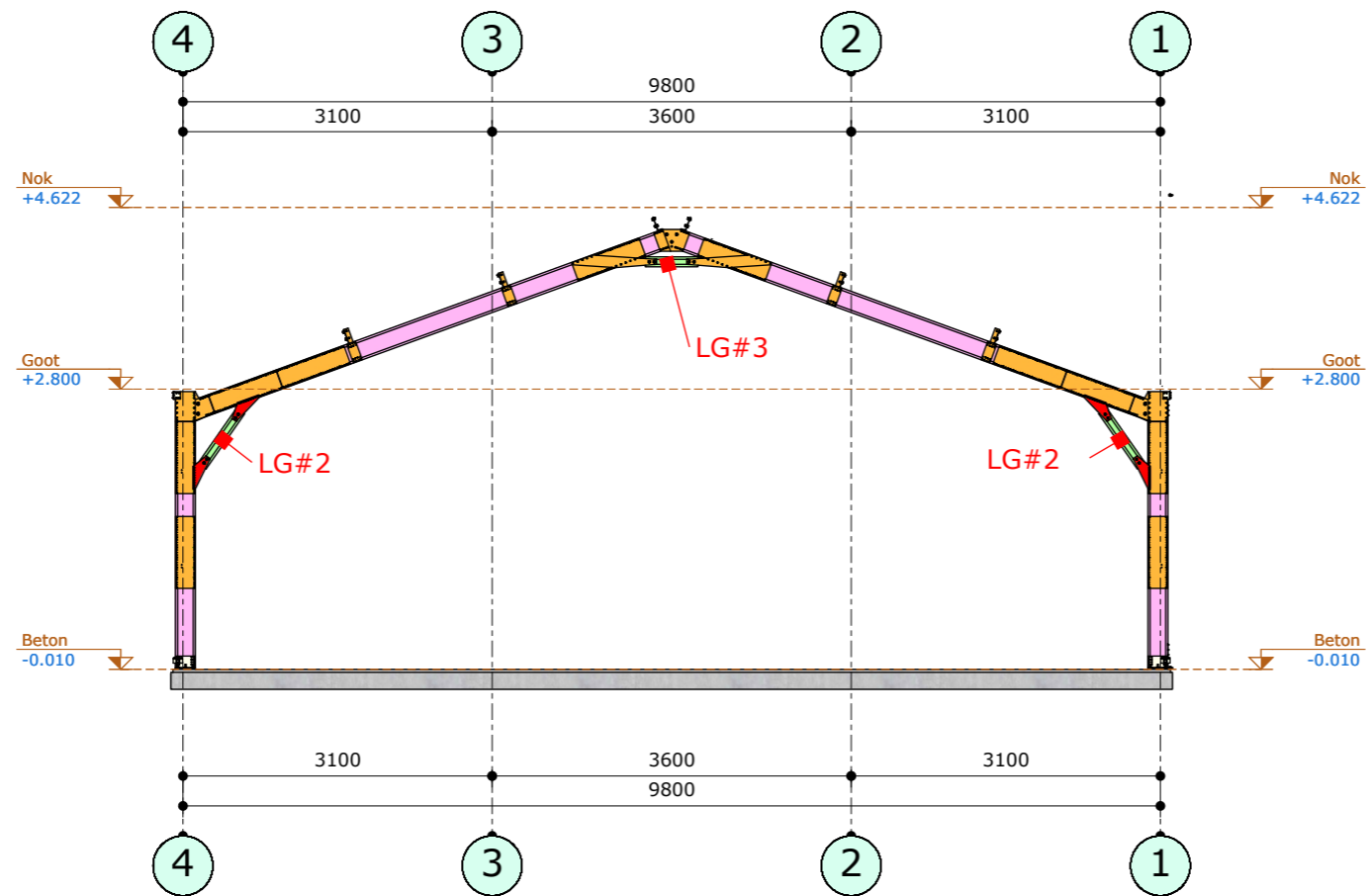

## STRAMIEN B + C



Reijrink Skellet B.V.  
 Kalundborg 10 t: +31(0)13 504 1585  
 5026 SE Tilburg e: info@reijrink-skellet.com  
 Nederland w: http://www.reijrink-skellet.com

OPDRACHT: Loods 15 x 10 x 2.8m

FASE: D.O.

BOUWPLAATS:

OPMERKINGEN: - Incl. pv-cellen

OPDRACHTGEVER: Huisman Gemert  
 Oost-Om 29  
 5422 VX Gemert  
 Nederland

WIJZIGINGEN:	versie	datum	wijziging

INHOUD: STRAMIEN B + C

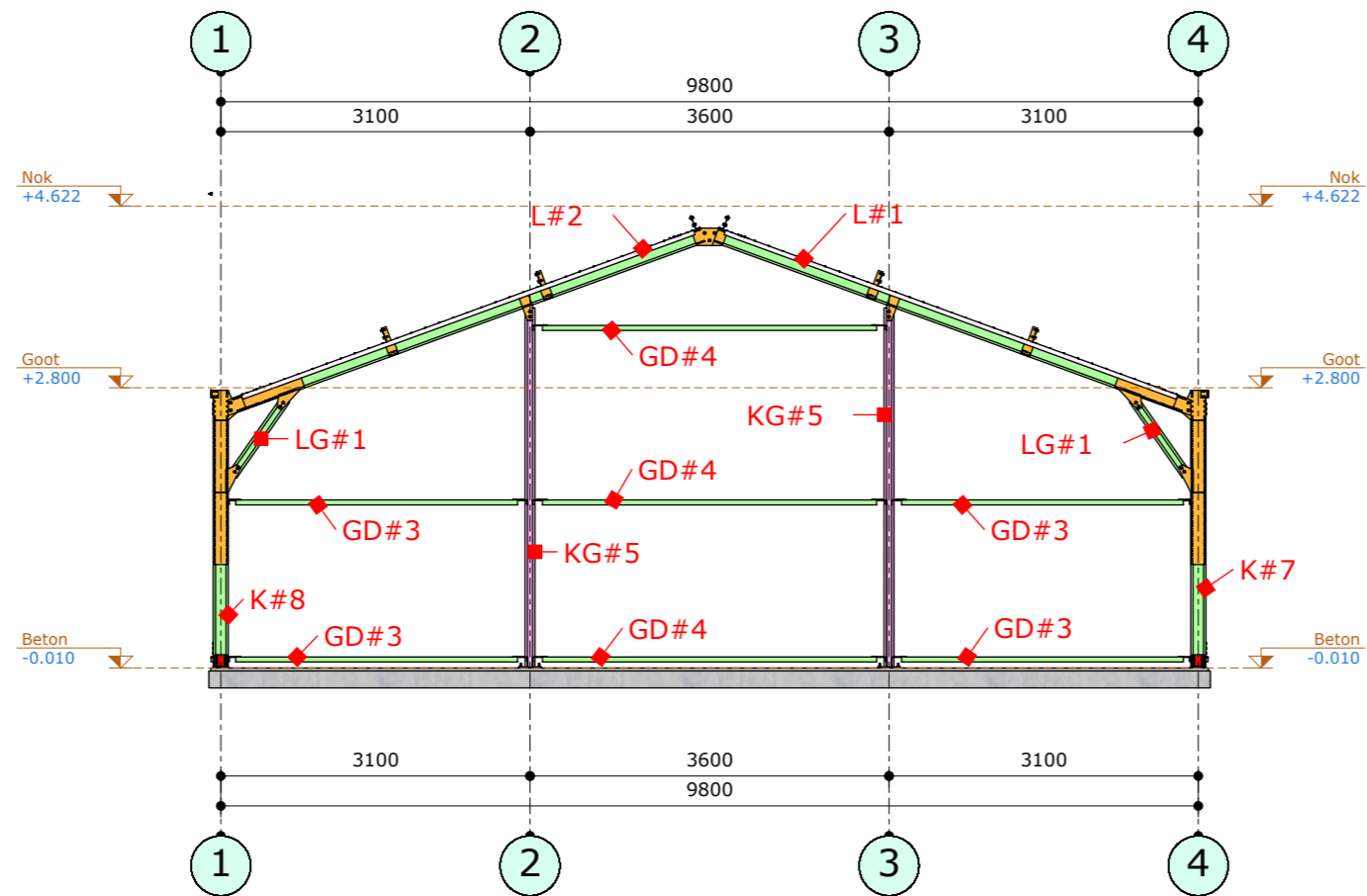

## STRAMIEN D



Reijrink Skellet B.V.  
 Kalundborg 10  
 5026 SE Tilburg  
 Nederland  
 t: +31(0)13 504 1585  
 e: info@reijrink-skellet.com  
 w: http://www.reijrink-skellet.com

OPDRACHT: Loods 15 x 10 x 2.8m

FASE: D.O.

BOUWPLAATS:

OPMERKINGEN: - Incl. pv-cellen

OPDRACHTGEVER: Huisman Gemert  
 Oost-Om 29  
 5422 VX Gemert  
 Nederland

WIJZIGINGEN:	versie	datum	wijziging

INHOUD: STRAMIEN D



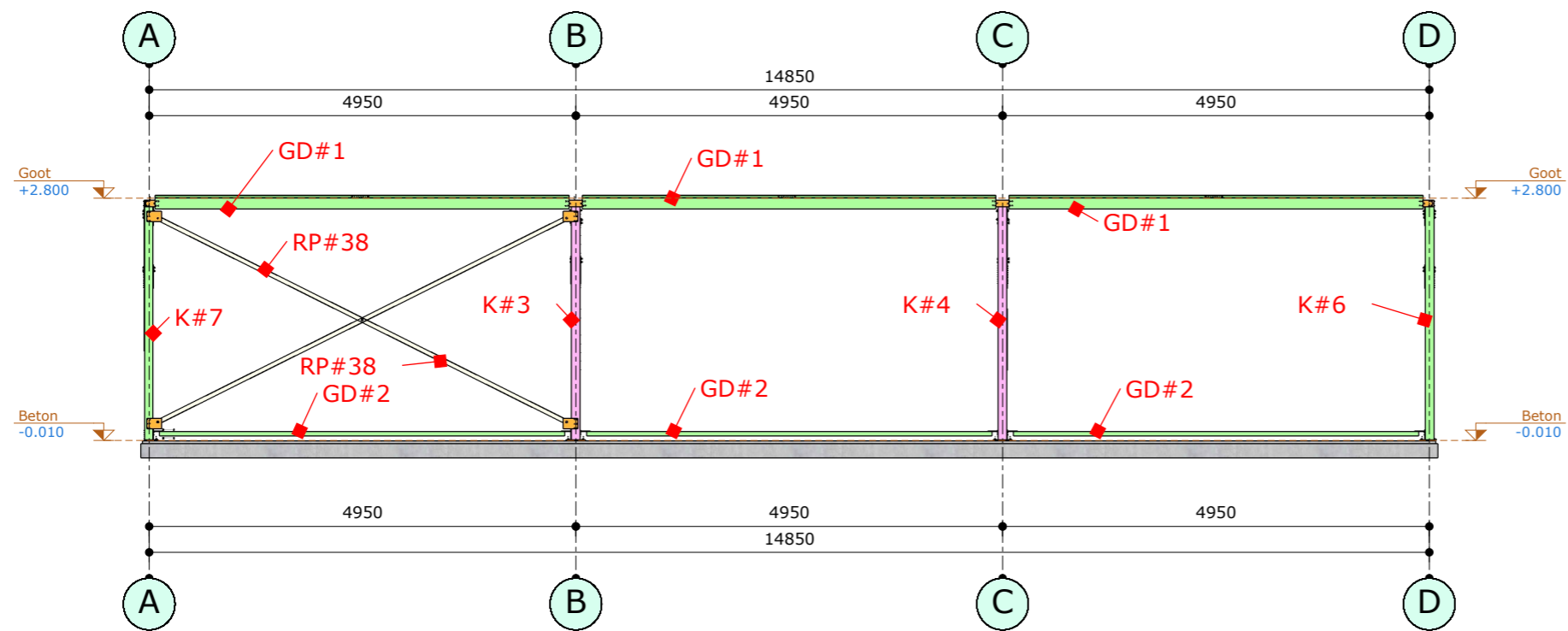

**Indien raampakket zie P. RAAMPAKKET 1 + 1.2 + 1.3 + 1.4**

## STRAMIEN 4



Reijrink Skellet B.V.  
 Kalundborg 10  
 5026 SE Tilburg  
 Nederland  
 t: +31(0)13 504 1585  
 e: info@reijrink-skellet.com  
 w: http://www.reijrink-skellet.com

OPDRACHT: Loods 15 x 10 x 2.8m

FASE: D.O.

BOUWPLAATS:

OPMERKINGEN: - Incl. pv-cellen

OPDRACHTGEVER: Huisman Gemert  
 Oost-Om 29  
 5422 VX Gemert  
 Nederland

WIJZIGINGEN:	versie	datum	wijziging

INHOUD: STRAMIEN 4

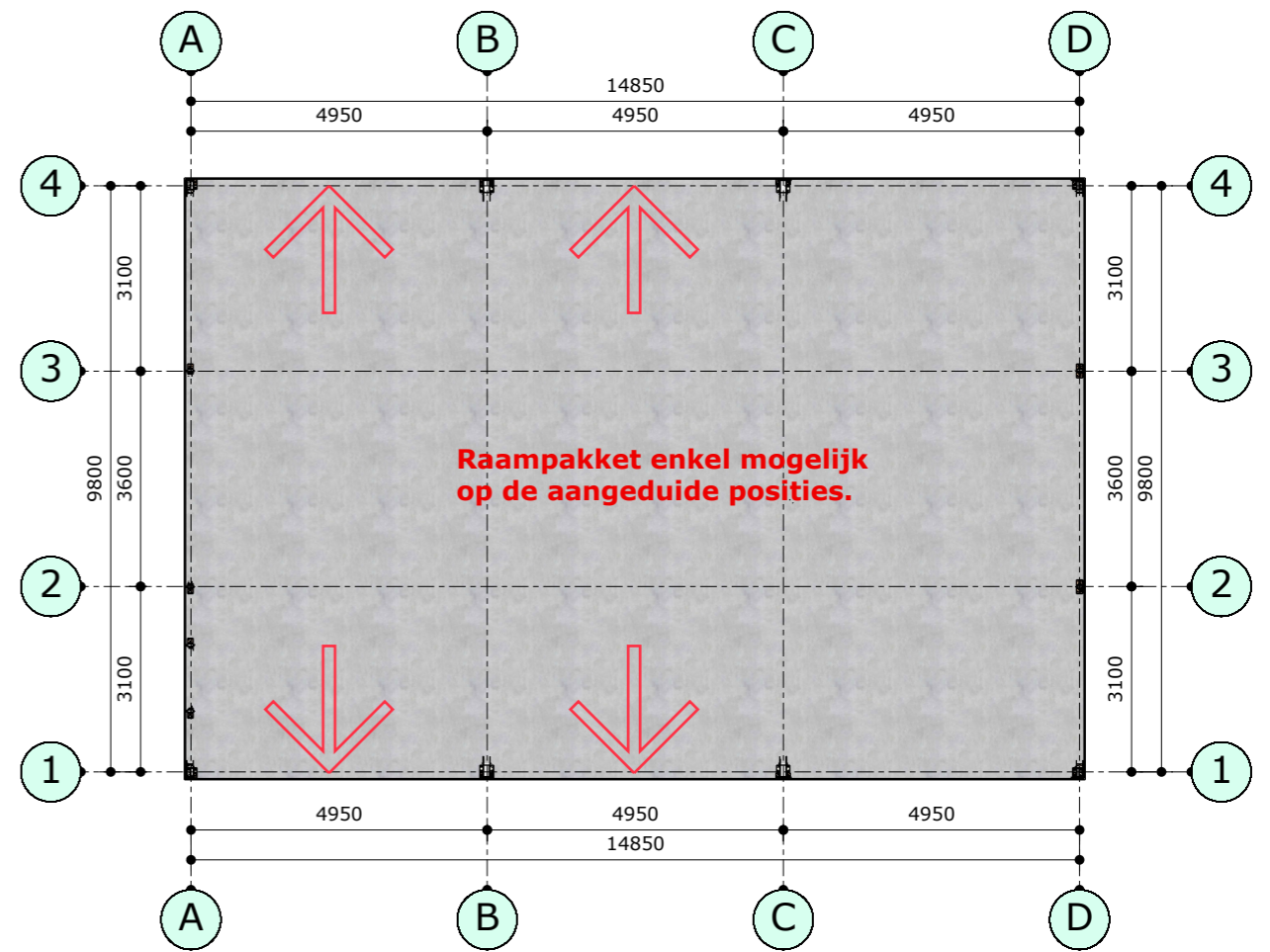
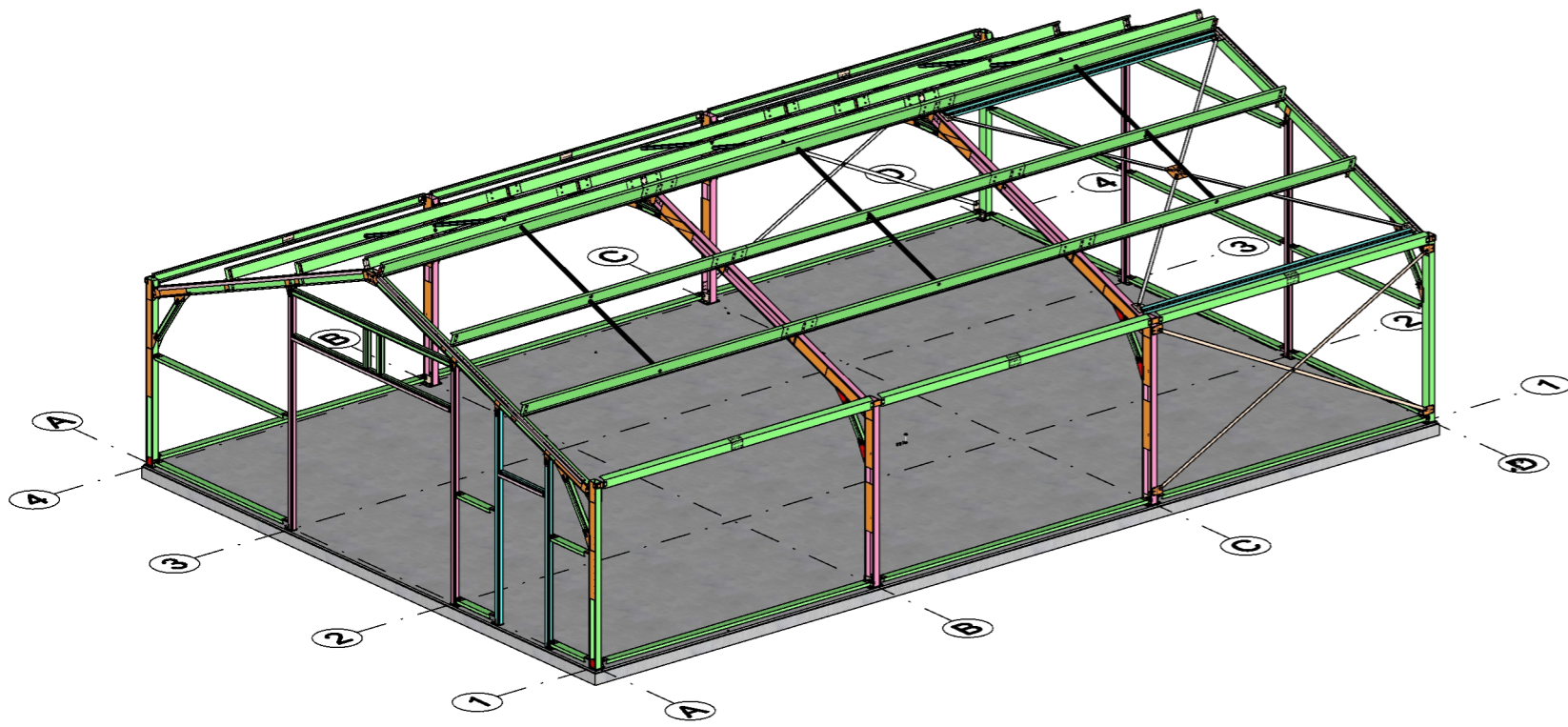

**Onderdelen raampakket**

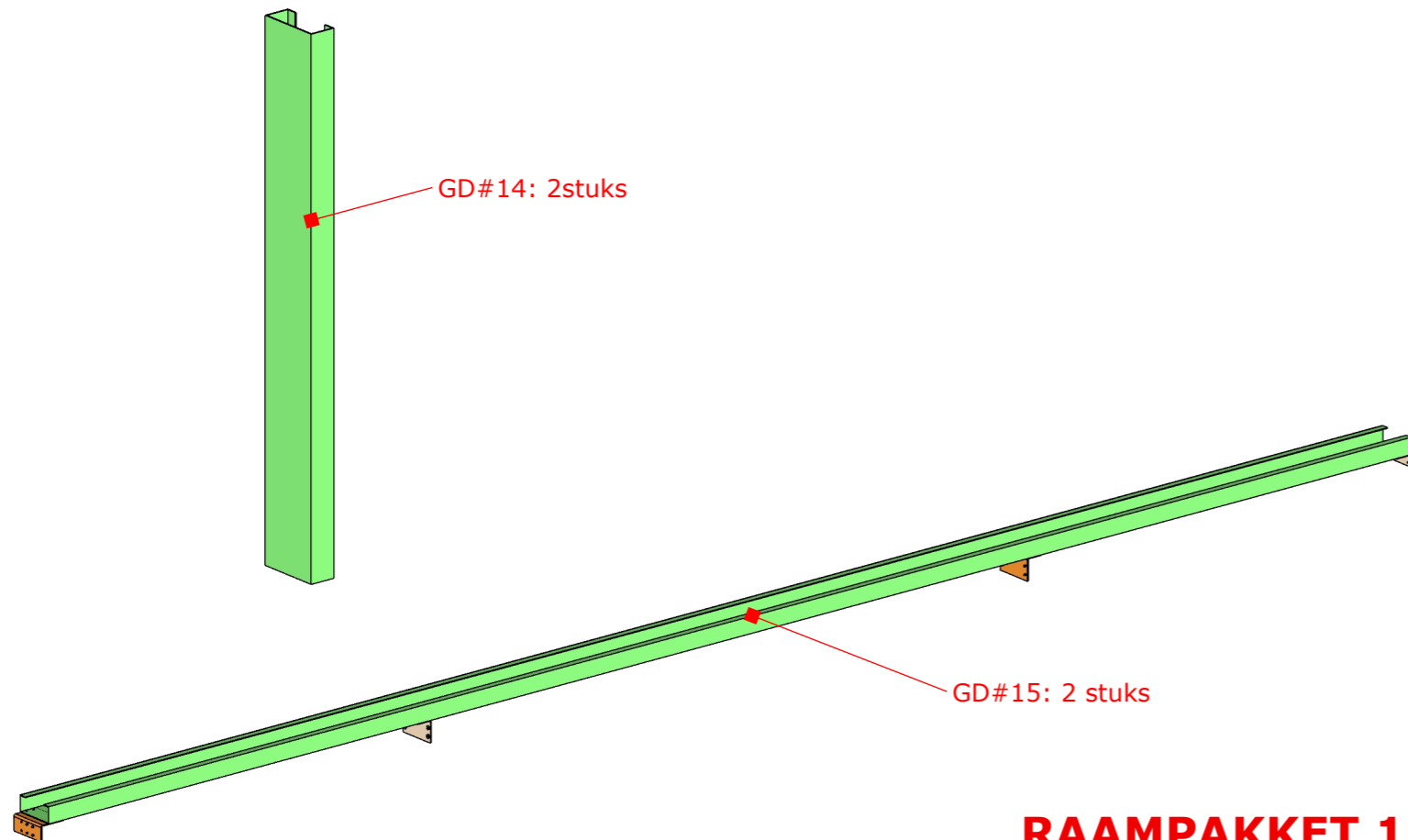

**RAAMPAKKET 1**



Reijrink Skellet B.V.  
 Kalundborg 10  
 5026 SE Tilburg  
 Nederland  
 t: +31(0)13 504 1585  
 e: info@reijrink-skellet.com  
 w: http://www.reijrink-skellet.com

OPDRACHT:	Loods 15 x 10 x 2.8m															
FASE:	D.O.															
BOUWPLAATS:																
OPMERKINGEN:	- Incl. pv-cellen															
OPDRACHTGEVER:	Huisman Gemert Oost-Om 29 5422 VX Gemert Nederland															
WIJZIGINGEN:	<table border="1"> <thead> <tr> <th>versie</th> <th>datum</th> <th>wijziging</th> </tr> </thead> <tbody> <tr><td> </td><td> </td><td> </td></tr> <tr><td> </td><td> </td><td> </td></tr> <tr><td> </td><td> </td><td> </td></tr> <tr><td> </td><td> </td><td> </td></tr> </tbody> </table>	versie	datum	wijziging												
versie	datum	wijziging														
INHOUD:	RAAMPAKKET 1															

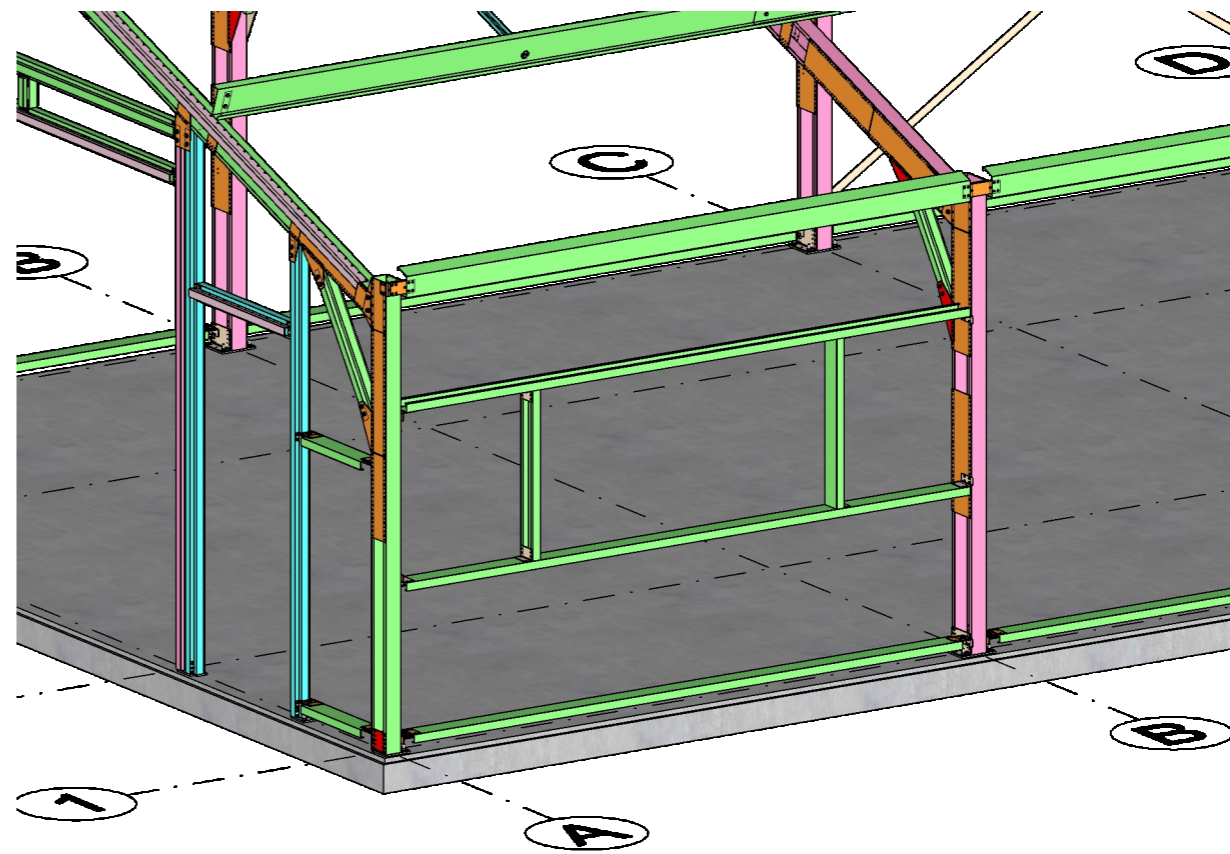
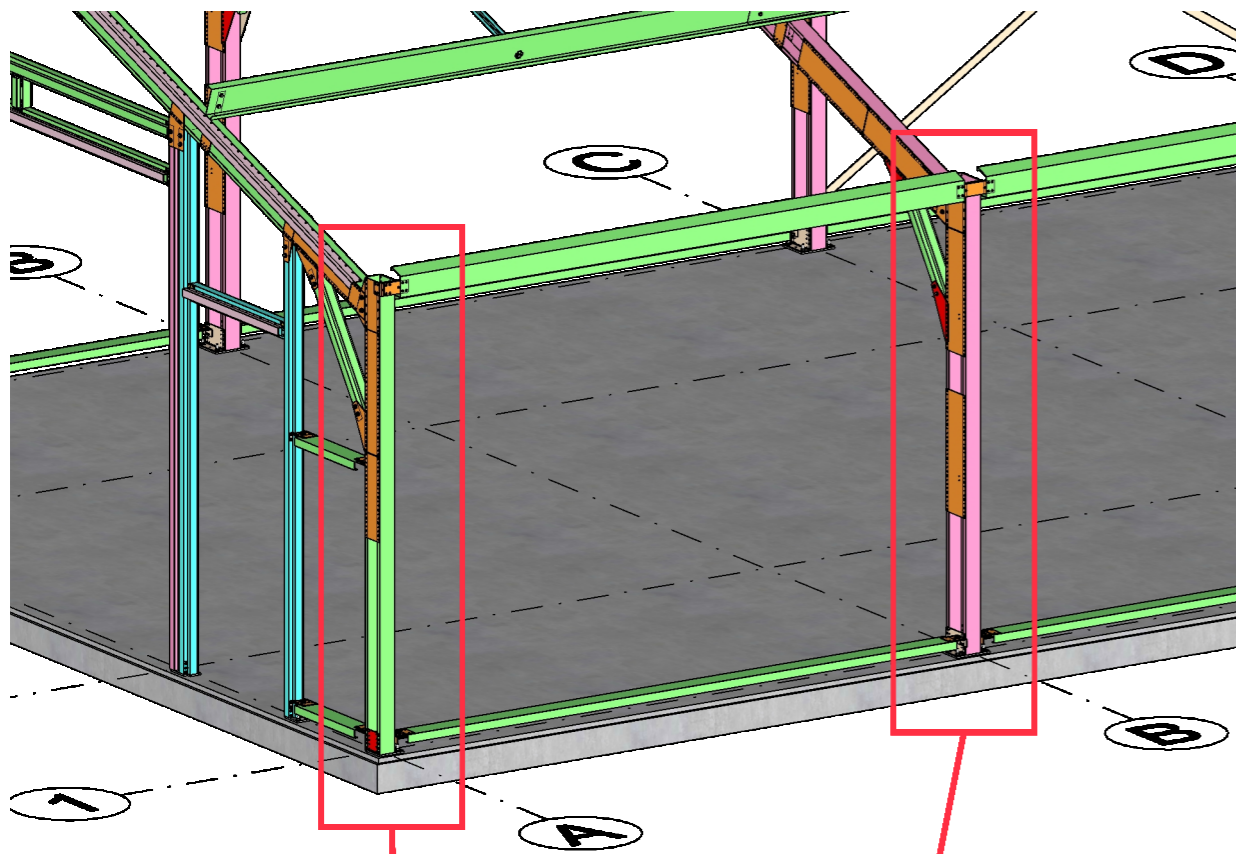

Voorbeeld raampakket op willekeurige positie

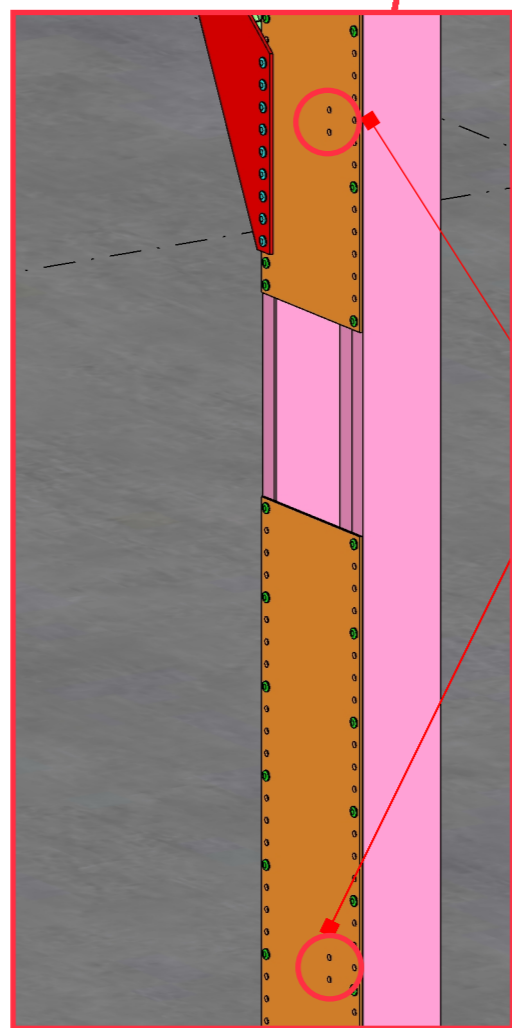
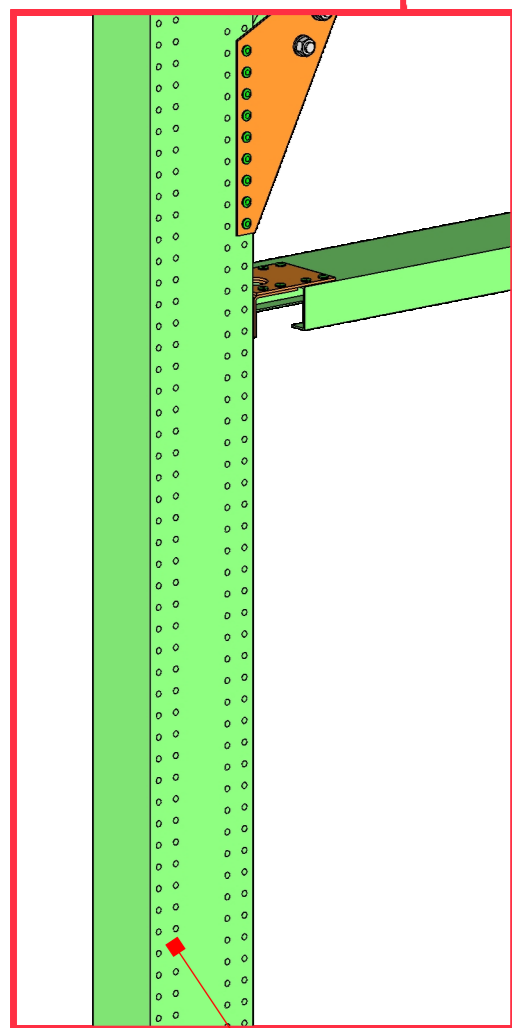

Gaatjes voorzien speciaal voor de raampakketten Hier GD#15 op bevestigen.

Op de rug van de C-profielen zijn rasterpaten voorzien voor de bevestiging van GD#15. voor juiste hoogte zie p. RAAMPAKKET 1.3

## RAAMPAKKET 1.2



Reijrink Skellet B.V.  
 Kalundborg 10  
 5026 SE Tilburg  
 Nederland  
 t: +31 (0)13 504 1585  
 e: info@reijrink-skellet.com  
 w: http://www.reijrink-skellet.com

OPDRACHT: Loods 15 x 10 x 2.8m

FASE: D.O.

BOUWPLAATS:

OPMERKINGEN: - Incl. pv-cellen

OPDRACHTGEVER: Huisman Gemert  
 Oost-Om 29  
 5422 VX Gemert  
 Nederland

WIJZIGINGEN: versie datum wijziging

versie	datum	wijziging

INHOUD: RAAMPAKKET 1.2



